

Electric ovens

INSTRUCTION BOOKLET

Please read this instruction booklet before using the appliance

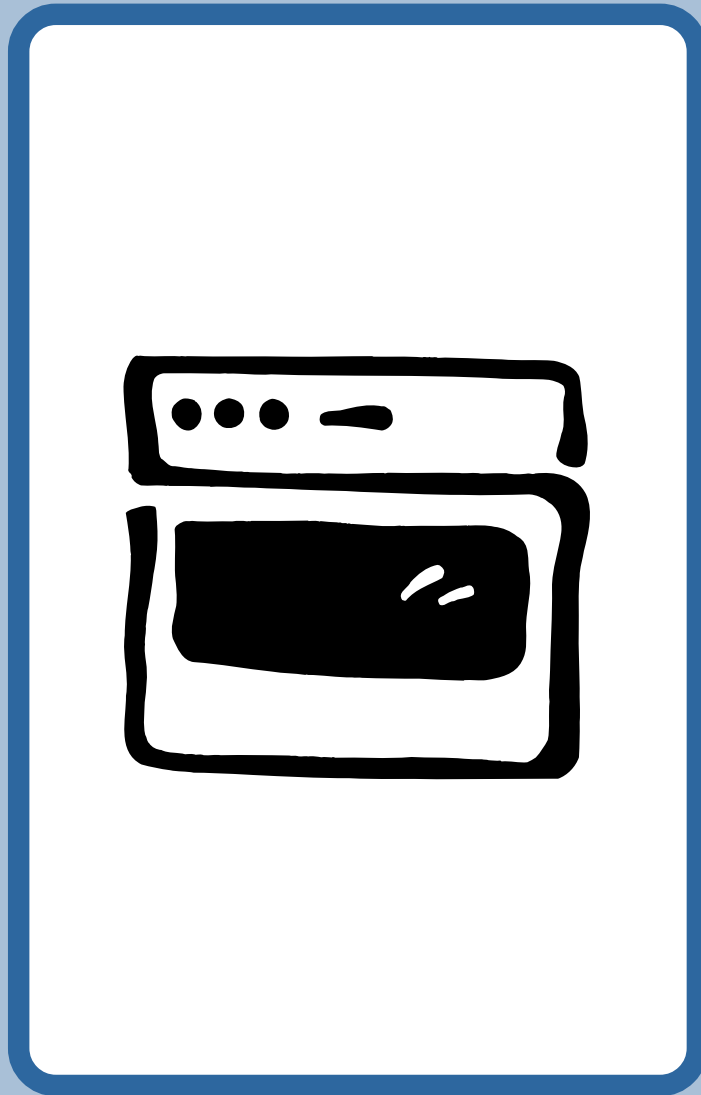

 **Electrolux Premier**
EPSOM

Important Safety Information



You **MUST** read these warnings carefully before installing or using the oven. If you need assistance, contact our Customer Care Department on 08705 950950

Installation

- This oven must be installed by qualified personnel to the relevant British Standards.
- This oven is heavy. Take care when moving it.
- Remove all packaging, both inside and outside the oven, before using the oven.
- Do not attempt to modify the oven in any way.

Child Safety

- This oven is designed to be operated by adults. Do not allow children to play near or with the oven.
- The oven gets hot when it is in use. Children should be kept away until it has cooled.

During Use

- This oven is intended for domestic cooking only. It is not designed for commercial or industrial purposes.
- Never line any part of the oven with aluminium foil.
- Do not allow heatproof cooking material, e.g. roasting bags, to come into contact with oven elements.
- Never place plastic or any other material which may melt in or on the oven.
- Do not place sealed cans or aerosols inside the oven. They may explode if they are heated.
- Do not hang towels, dishcloths or clothes from the oven or its handle.
- Do not use this oven if it is in contact with water and never operate it with wet hands.
- Take great care when heating fats and oils as they will ignite if they become too hot.
- Always use oven gloves to remove and replace food in the oven.
- Ensure that all control knobs are in the OFF position when not in use.
- Do not leave cookware containing foodstuffs, e.g. fat or oil in or on the oven in case it is inadvertently switched ON.
- When using other electrical appliances, ensure the cable does not come into contact with the hot surfaces of the oven.

Maintenance and Cleaning

- Only clean this oven in accordance with the instructions.
- The oven should be kept clean at all times. A build-up of fats or other foodstuffs could result in a fire, especially in the grill pan.

- Always allow the oven to cool down and switch off the electrical supply before carrying out any cleaning or maintenance work.

Service

- This oven should only be repaired or serviced by an authorised Service Engineer and only genuine approved spare parts should be used.

Environmental Information

- After installation, please dispose of the packaging with due regard to safety and the environment.
- When disposing of an old appliance, make it unusable, by cutting off the cable. Remove any door catches, to prevent small children being trapped inside.

Keep this instruction book for future reference and ensure it is passed on to any new owner.

Guide to Use the instructions

The following symbols will be found in the text to guide you throughout the Instructions:



Safety Instructions



Step by step instructions for an operation



Hints and Tips



Environmental information



This appliance complies with the following **E.E.C. Directives:**

- * **73/23 - 90/683** (Low Voltage Directive);
- * **93/68** (General Directives);
- * **89/336** (Electromagnetical Compatibility Directive).

and subsequent modifications

Contents

For the User

Important Safety Information	2
Description of the Appliance	3
Controls	4
24 hour Clock and Timer	5
Using the Oven	7
Hints and Tips	7
Before the First Use	7
Using the Fan Oven	8
Defrosting	10
Grilling	11
Cleaning the Oven	13
Something not working	14
Service and Spare Parts	15
Guarantee Conditions	15

For the Installer

Electrical Connection	18
Technical Data	18
Building In	19

Oven Door Protection Device

(stainless steel models only)

All our appliances comply with the European safety standards. Nevertheless, in order to ensure the highest safety level, and avoid small children to be exposed to the heat when the appliance is operated, it is possible to fit a special protection device to the oven door. This device can be purchased in our Service Force Centres, specifying the relevant code (35791) and the Product No. shown on the rating plate.

Description of the Appliance

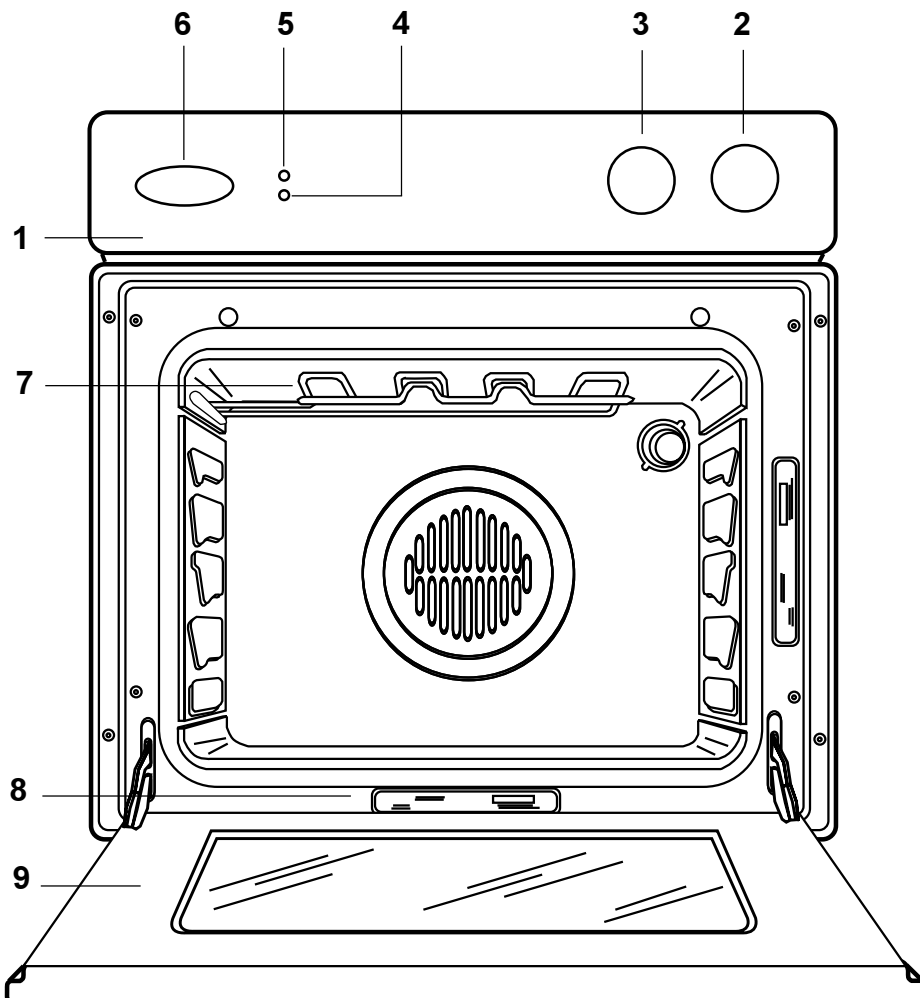







1. Control Panel
2. Thermostat Control Knob
3. Oven Function Control Knob
4. Thermostat Control Light
5. Mains on Light
6. Electronic programmer
7. Grill
8. Rating label
9. Oven door

Accessories

- Grill/Roasting pan
- Grill trivet
- Removable handles
- Anti-tip shelf (x2)

Controls

Oven Function Control Knob

-  Oven Light - The oven light will be on without any cooking function.
-  Inner grill element only - can be used for grilling small quantities.
-  Double Grill - The full grill element will be on.
-  Thermal Grilling - This function offers an alternative method of cooking food items, normally associated with conventional grilling. The grill element and the oven fan operate together, circulating hot air around the food.
-  Fan Oven cooking - This allows you to roast or roast and bake simultaneously using any shelf, without flavour transference.
-  Defrost Setting - This setting is intended to assist in thawing of frozen food.

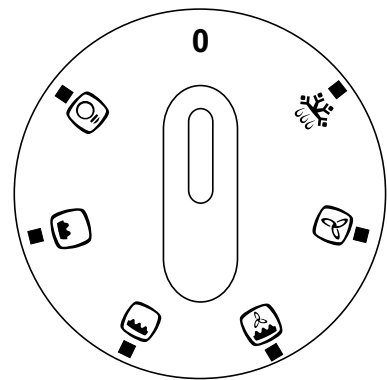

Thermostat Control Knob

Turn the thermostat control knob clockwise to select temperatures between 50°C and 250°C (MAX).

Mains on Light

The mains on light will come on when the oven function control knob is set.

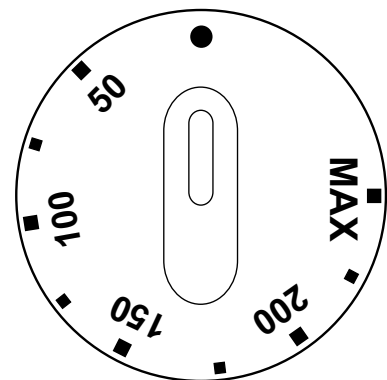

Thermostat Control Light

The thermostat control light will come on when the thermostat control knob is turned. The light will remain on until the correct temperature is reached. It will then cycle on and off to show the temperature is being maintained.

The Safety Thermostat

This oven is provided with a safety thermostat. In case of malfunctioning of the main thermostat, and consequent over-heating, the safety device will stop the power supply to the appliance. If this happens, call your local Service Force Centre. Under no circumstances should you attempt to repair the appliance yourself.





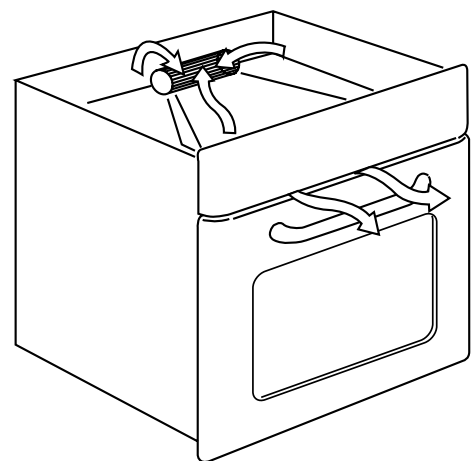

Cooling fan

The cooling fan operates during cooking. Air is expelled through vents between the oven door and the control panel, as shown in the diagram.

The cooling fan may run on after the oven is switched off to keep the controls cool. This is quite normal.



24 hour Clock and Timer

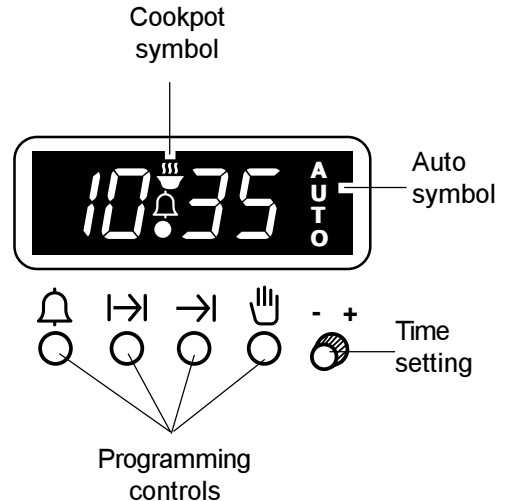

-  Minute minder
-  Cooking duration
-  End of cooking time
-  Manual function
-  Cookpot symbol - This will be displayed when a program is in operation.
-  Auto symbol - This will be displayed when the oven has been programmed for automatic operation.
-  - + Time setting knob





The electronic timer can indicate the time of day, operate as a minute minder and automatically operate the oven. Before the oven can be operated, the time of day must be set on the electronic timer. Please note that this is a 24 hour clock. For example, 2pm is shown as 14:00.

In case of loss of power, all the settings (time of day, set program or program in operation), will be cancelled. When the power is restored, the numbers on the display will flash, and the timer has to be reset.

TO SET THE TIME OF DAY

Press buttons  and , and at the same time turn the time setting knob until the correct time of day is displayed.

TO SET THE MINUTE MINDER

Press button  and at the same time turn the setting time knob until the duration time is displayed (maximum 23 hours, 59 minutes). Our diagram shows the timer set for 35 minutes. After a few seconds the time of day will show in the display. To check the number of minutes remaining, press the  button. At the end of the timed period an alarm will sound. To switch off the alarm press button .

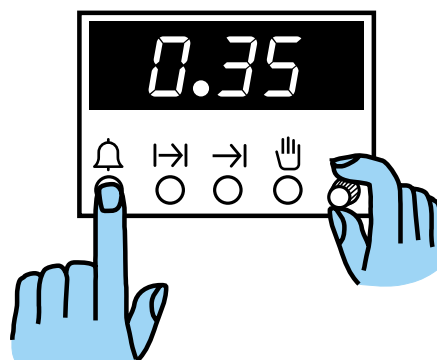
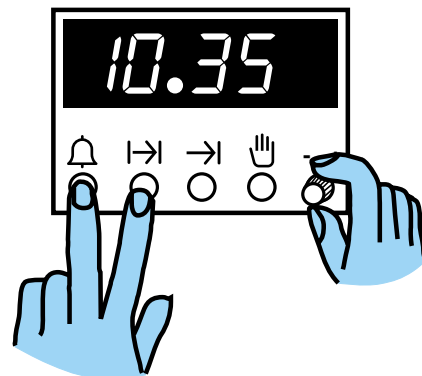

MANUAL FUNCTION

Press button  to set the oven for manual function.

TO SET THE TIMER TO SWITCH OFF ONLY

This is useful if you want to begin cooking immediately but have the oven switch off automatically.

1. Set the oven function control knob and the thermostat control knob on the required settings.
2. Place food in the oven.
3. Press button  and, at the same time, turn the time setting knob until the required cooking duration is displayed.

Our diagram shows the timer set for 1 hour 10 minutes. At the end of the cooking time the oven will switch off, an alarm will sound. Turn the oven function and thermostat control knob to zero. To switch off the alarm press button

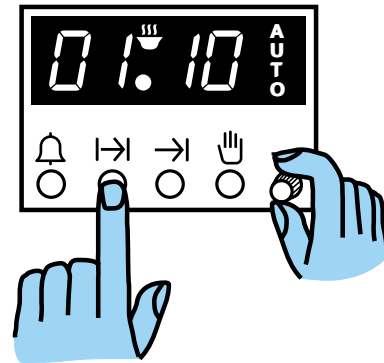
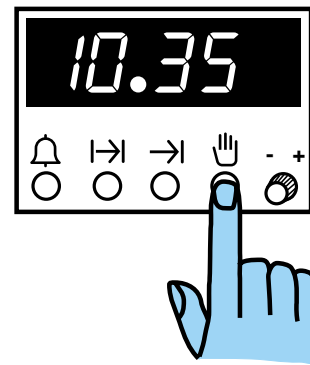

TO SET THE TIMER TO SWITCH THE OVEN ON AND OFF



1. Ensure the clock is showing the right time of day.
2. Carry out steps 1, 2 and 3 as explained in "To set the timer to switch off only".
3. Press button  and at the same time turn the time setting knob until the end cooking time is displayed.

Our diagram shows the end cooking time set for 7:35 pm.

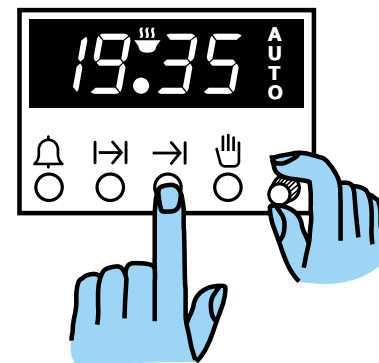
At the end of the cooking time turn the oven function and thermostat control knob to zero.



TO CANCEL A PROGRAMME

1. Press button  and, at the same time, turn the time setting knob until the cooking duration is set on "zero".
2. If the end cooking time has been set too, press button  and at the same time turn the time setting knob until the end cooking time is set on "zero".

Before the First Use



Remove **all packaging**, both inside and outside the oven, before using the appliance.

Before first use, the oven should be heated without food. During this time, an unpleasant odour may be emitted. This is quite normal.

1. Set the programmer to manual function.
2. Switch the oven function control knob to fan cooking .
3. Set the thermostat control knob to MAX.
4. Open a window for ventilation.
5. Allow the oven to run empty for approximately 45 minutes.

This procedure should be repeated with the grill  function for approximately 5-10 minutes.

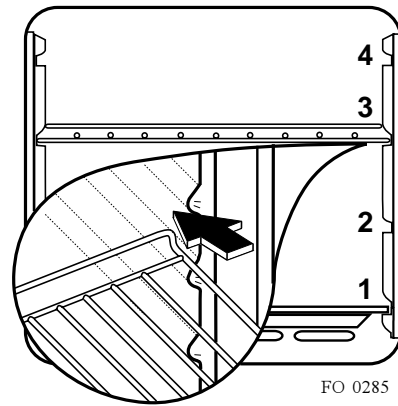

FO 0285

Using the Oven



- **Always cook with the oven door closed.**
- Stand clear when opening the drop down oven door. **Do not** allow it to fall open - support the door using the door handle, until it is fully open.



- The oven has four shelf levels, and is supplied with two shelves. The shelf positions are counted from the bottom of the oven as shown in the diagram.

It is important that these shelves are correctly positioned as shown in the diagram.

- Do not place cookware directly on the oven base.

Accessories

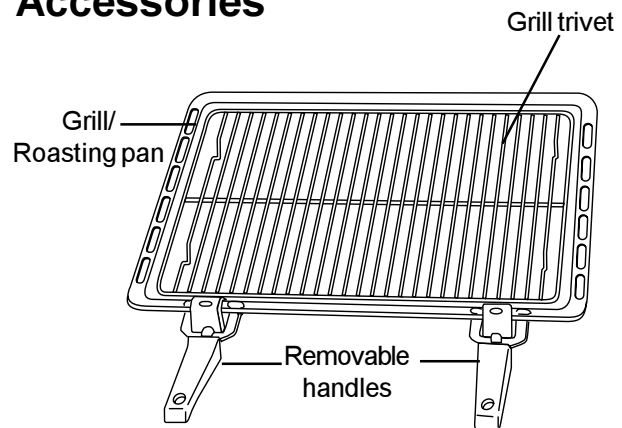

Hints and Tips

Condensation and steam

When food is heated it produces steam in the same way as a boiling kettle. The oven vents allow some of this steam to escape. However, **always stand back from the oven when opening the oven door** to allow any build up of steam or heat to release.

If the steam comes into contact with a cool surface on the outside of the oven, e.g. a trim, it will condense and produce water droplets. This is quite normal and is not a fault with the oven.

To prevent discoloration, regularly wipe away condensation and also soilage from surfaces.

Cookware

- Use any oven proof cookware which will withstand temperatures of 250°C.
- Baking trays, oven dishes, etc. should not be placed directly against the grid covering the fan at the back of the oven, or placed on the oven base.
- Do not use baking trays larger than 30 cm x 35 cm (12 in x 14 in) as they will restrict the circulation of heat and may affect performance.

ANTI-TIP SHELF

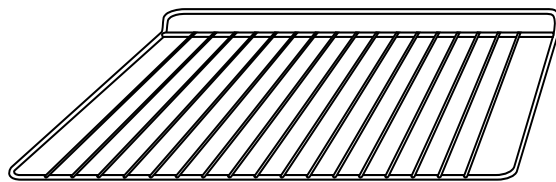

The effects of dishes on cooking results

Dishes and tins vary in their thickness, conductivity, colour, etc. which affects the way they transmit heat to the food inside them.

- A** Aluminium, earthenware, oven glassware and bright shiny utensils reduce cooking and base browning.
- B** Enamelled cast iron, anodized aluminium, aluminium with non-stick interior and coloured exterior and dark, heavy utensils increase cooking and base browning.

Using the Fan Oven

The air inside the oven is heated by the element around the fan situated behind the back panel. The fan circulates hot air to maintain an even temperature inside the oven.

The advantages of cooking with this function are:

●Faster Preheating

As the fan oven quickly reaches temperature, it is not usually necessary to preheat the oven although you may find that you need to allow an extra 5-7 minutes on cooking times. For recipes which require higher temperatures, best results are achieved if the oven is preheated first, e.g. bread, pastries, scones, souffles, etc.

●Lower Temperatures

Fan oven cooking generally requires lower temperatures than conventional cooking.

Follow the temperatures recommended in the chart on page 11 or remember to reduce temperatures by about 20-25°C for your own recipes which use conventional cooking.

●Even Heating for Baking

The fan oven has uniform heating on all runner positions. This means that batches of the same food can be cooked in the oven at the same time. However, the top shelf may brown slightly quicker than the lower one.

This is quite usual. There is no mixing of flavours between dishes.

How to Use the Fan Oven

1. Turn the oven function control knob to .
2. Turn the thermostat control to the required temperature.

THINGS TO NOTE

- The oven light will come on when the oven function control knob is set.
- The oven fan will operate continually during cooking.
- The thermostat control light will remain on until the correct temperature is reached. It will then cycle on and off to show the temperature is being maintained.

Hints and Tips

Runner positions are not critical, but make sure the shelves are evenly spread.

When cooking more than one dish in the fan oven, place dishes centrally on the shelves rather than several dishes on one shelf.

When the oven is full, you may need to allow slightly longer cooking time.

A shelf may be placed on the floor of the oven. Place dishes on a shelf in this position rather than on the oven base, to allow air circulation around the food.

When the oven is full of the same food, e.g. equal trays of small cakes or equal size victoria sandwich cakes, then they will be cooked in the same time and removed from the oven together. When different sizes of trays or types of food, e.g. biscuits and cakes are cooked, they will not necessarily be ready together.

The fan oven can be used to heat foods through without thawing first, e.g. fruit tarts, mince pies, sausage rolls, and other small pastry items. Use a temperature of 190-200°C and allow 20-40 minutes (depending on the quantity of food in the oven).

The use of too high temperatures can cause uneven browning. Check with the recommendations for oven temperatures given in the cooking charts, but be prepared to adjust the temperature by 10°C if necessary. Remember to reduce temperatures by about 20-25°C for your own conventional recipes.

When roasting do use the trivet in the meat tin. Fat and meat juices will drain into the meat tin below and can be used to make gravy. The trivet also prevents splashes of fat from soiling the oven interior.

The meat tin **should not** be placed on a heated hotplate as this may cause the enamel to crack.

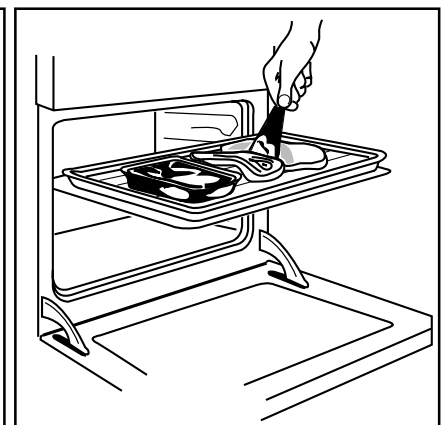
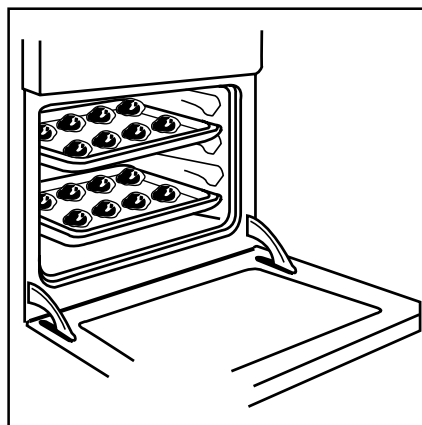
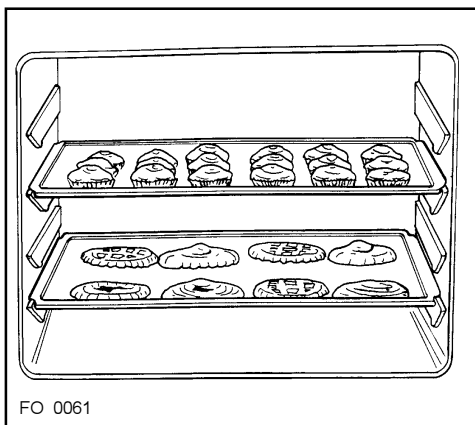

Cooking Chart

This chart is intended as a guide only. It may be necessary to increase or decrease the temperature to suit your individual requirements. Only experience will enable you to determine the correct setting for your personal requirements.

Food	Shelf Position	Cooking Temp (°C)	
Biscuits	Shelf positions are not critical but ensure that oven shelves are evenly spaced when more than one is used.	180-190	
Bread		210-220	
Casseroles		130-140	
Cakes: Small and queen		160-170	
Sponges		160-170	
Madeira		140-150	
Rich Fruit		130-140	
Christmas		130-140	
Meringues		90-100	
Fish		170-190	
Fruit Pies and Crumbles		190-200	
Milk Puddings		130-140	
Pastry: Choux		} 190-200	
Shortcrust			
Flaky			
Puff			
Plate Tarts	180		
Quiches/Flans	170-180		
Scones	210-220		
Roasting: Meat & Poultry	160-180		

When roasting, ensure the meat is cooked thoroughly, use a meat thermometer if preferred to check the centre temperature has reached the required temperature (see table below).

MEAT	TEMPERATURES
Beef	Rare - 60°C Medium - 70°C Well Done - 80°C
Pork	Well Done - 80°C
Lamb	Medium - 70°C Well Done - 80°C

Defrosting

The oven fan operates without heat and circulates the air, at room temperature, inside the oven. This increases the speed of defrosting. However, please note that the temperature of the kitchen will influence the speed of defrosting. This function is particularly suitable for delicate food which could be damaged by heat, e.g. cream filled gateaux, iced cakes, pastries, bread and other yeast products.

How to Use Defrosting

1. Turn the oven function control knob to .
2. Ensure the thermostat control knob is in the OFF position.

Hints and Tips

- Cover food with a lid, aluminium foil or plastic film to prevent drying out during defrosting.
- ALWAYS COOK THOROUGHLY IMMEDIATELY AFTER THAWING.
- Frozen food should be placed in a single layer when ever possible and turned over half way through the defrosting process.
- Only joints of meat and poultry up to 2 kg. (4 lb.) are suitable for defrosting in this way.

Refer to the following table for approximate defrosting times.

Food	Defrosting time (Mins)	Standing time (Mins)	Notes
Chicken 1000 g.	100-140	20-30	Place the chicken on an inverted saucer on a large plate. Defrost open and turn at half time or defrost covered with foil. Remove giblets as soon as possible.
Meat 1000 g.	100-140	20-30	Defrost open and turn at half time or cover with foil
Meat 500 g.	90-120	20-30	As above
Trout 150 g.	23-35	10-15	Defrost open
Strawberries 300 g.	30-40	10-20	Defrost open
Butter 250 g.	30-40	10-15	Defrost open
Cream 2 x 200 g.	80-100	10-15	Defrost open (cream is easy to whip even if parts of it are still slightly frozen)
Cake 1400 g.	60	60	Defrost open

The times quoted in the chart should be used as a guide only, as the speed of defrosting will depend on the kitchen temperature. For example, the colder the ambient temperature, the longer the defrosting time.

Grilling

 **Grilling must be carried out with the oven door closed. The grill pan handles must be removed from the pan.**

How to Use the Grill

1. Turn the oven control function knob on .
2. Turn the thermostat control knob on the required temperature.
3. Adjust the grid and grill pan runner position to allow for different thicknesses of food. Position the food close to the element for faster cooking and further away for more gentle cooking.

Preheat the grill on a full setting for a few minutes before sealing steaks or toasting. Adjust the heat setting and the shelf as necessary, during cooking.

During cooking, the cooling fan and the thermostat control light will operate in the same way as described for the fan oven function.

How to Use the Inner Grill Element

The inner grill provides quick direct heat to the central area of the grill pan. By using the inner grill element for cooking small quantities, it can help to save energy.

1. Turn the oven control function knob on .
2. Turn the thermostat control knob on the required temperature.
3. Adjust the grid and grill pan runner position to allow for different thicknesses of food and follow the instructions for grilling.

Hints and Tips

- Most foods should be placed on the grid in the grill pan to allow maximum circulation of air to lift the food out of the fats and juices. Food such as fish, liver and kidneys may be placed directly on the grill pan, if preferred
- Food should be thoroughly dried before grilling to minimise splashing. Brush lean meats and fish lightly with a little oil or melted butter to keep them moist during cooking
- Accompaniments such as tomatoes and mushrooms may be placed underneath the grid when grilling meats
- When toasting bread, we suggest that the top runner position is used.
- The food should be turned over during cooking, as required.

The grill element is controlled by the thermostat. During cooking, the grill cycles on and off to prevent overheating.

How to Use the Thermal Grill

Thermal grilling offers an alternative method of cooking food items normally associated with conventional grilling. The grill element and the oven fan operate alternately, circulating hot air around the food. The need to check and turn the food is reduced. Thermal grilling helps to minimize cooking smells in the kitchen.

With the exception of toast and rare steaks, you can thermally grill all the foods you would normally cook under a conventional grill. Cooking is more gentle, therefore food generally takes a little longer to cook with thermal grilling compared with conventional grilling. One of the advantages is that larger loads can be cooked at the same time.

1. Turn the oven control function knob on .
2. Turn the thermostat control knob on the required temperature. **Select a maximum temperature of 200°C and do not exceed 1 hour of operation.**
3. Adjust the grid and grill pan runner position to allow for different thicknesses of food and follow the instructions for grilling.

Hints and Tips

Prepare foods in the same way as for conventional grilling. Brush lean meats and fish lightly with little oil or butter to keep them moist during cooking.

If thermal grilling on more than one level, it may be necessary to interchange the food on the shelves during cooking.

A general guide to cooking times is given below but these times may vary slightly depending on the thickness and quantity of food being cooked.

Cooking Chart - Grilling

FOOD	Grill and Inner Grill Element		Thermal Grill	
	Temp (°C)	Time (Mins per side)	Temp (°C)	Time (Mins)
Bacon Rashers	210	2-3	200	8-12
Beefburgers 200		6-10	190	10-15
Chicken Joints	170	10-15	160	35-45
Chops - Lamb	180	7-10	170	20-25
- Pork	180	10-15	170	25-35
Fish - Whole Trout/Herring	170	8-12	170	10-20
- Fillets Plaice/Cod	170	4-6	170	10-20
Kebabs	180	10-15	170	20-30
Kidneys - Lamb/Pig	170	4-6	180	10-15
Liver - Lamb/Pig	170	5-10	180	20-30
Sausages	180	10-15	190	10-15
Toast	250	1-2	--	
Heating through and Browning, e.g. au-gratin, lasagne, shepherd's pie.	-	-	170 depending on size	20-30 depending on size
Browning dishes only	230	3-5	--	

Cleaning the Oven



Before cleaning always allow the cooling fan to cool the cooker down before switching off at the electricity supply.

The oven should be kept clean at all times. A build-up of fats or other foodstuffs could result in a fire, especially in the grill pan.

Cleaning materials

Before using any cleaning materials on your oven, check that they are suitable and that their use is recommended by the manufacturer.

Cleaners that contain bleach should NOT be used as they may dull the surface finishes. Harsh abrasives should also be avoided.

External cleaning

Regularly wipe over the control panel, oven door and door seal using a soft cloth well wrung out in warm water to which a little liquid detergent has been added.



To prevent damaging or weakening the door glass panels avoid the use of the following:

- Household detergent and bleaches
- Impregnated pads unsuitable for non-stick saucepans
- Brillo/Ajax pads or steel wool pads
- Chemical oven pads or aerosols
- Rust removers
- Bath/Sink stain removers

Clean the outer and inner door glass using warm soapy water. Should the inner door glass become heavily soiled it is recommended that a cleaning product such as Hob Brite is used.



DO NOT clean the oven door while the glass panels are warm. If this precaution is not observed the glass panel may shatter. If the door glass panel becomes chipped or has deep scratches, the glass will be weakened and must be replaced to prevent the possibility of the panel shattering. Contact your local Service Force Centre who will be pleased to advise further.

Oven Cavity

The enamelled oven cavity is best cleaned whilst the oven is still warm.

Wipe the oven over with a soft cloth soaked in warm soapy water after each use. From time to time it will be necessary to do a more thorough cleaning, using a proprietary oven cleaner.

If the soilage has become set, after the oven has cooled down, the following process will help to soften the splatters to help make cleaning easier.

1. Place the grill/ meat pan on the oven shelf positioned in the lowest runner.
2. Add a few drops of washing-up liquid to the pan and fill to about 12 mm. with boiling water from the kettle.
3. Close the oven door, turn the oven function knob on fan oven  and set the thermostat knob on 50°C.
4. After 15 minutes, turn off the thermostat and allow the fan oven to continue without heat for a further 5 minutes, when the temperature of the water will have cooled down.
5. Carefully remove the pan of water from the oven and use normal oven cleaners to clean away soil residues.
6. Leave a small amount of soapy water to soak into any burned on spillage on the floor of the oven for a longer time if necessary.

Replacing The Oven Light

If the oven bulb needs replacing, it must comply with the following specifications:

- Electric power: 15W,
- Electric rate: 230-240 V (50 Hz),
- Resistant to temperatures of 300°C,
- Connection type: E14

These bulbs are available from your local Service Force Centre.

To replace the faulty bulb:

1. Ensure the oven is disconnected from the electrical supply.
2. Push in and turn the glass cover anticlockwise.
3. Remove the faulty bulb and replace with the new one.
4. Refit the glass cover and restore the electrical supply.

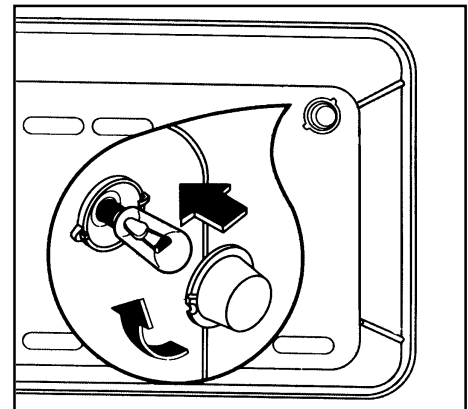

FO 0287

Something not working

If the appliance is not working correctly, please carry out the following checks, before contacting your local Electrolux Service Force Centre.

IMPORTANT: If you call out an engineer to a fault listed below, or to repair a fault caused by incorrect use or installation, a charge will be made even if the appliance is under guarantee.

SYMPTOM	SOLUTION
<ul style="list-style-type: none"> ■ The oven does not come on 	<ul style="list-style-type: none"> ◆ Check the oven is in manual operation and that both a cooking function and temperature have been selected. ◆ Check the appliance is wired in properly, and the socket switch or the switch from the mains supply to the oven are ON.
<ul style="list-style-type: none"> ■ The oven temperature light does not come on 	<ul style="list-style-type: none"> ◆ Select a temperature with the thermostat control knob ◆ Select a function with the oven function control knob.
<ul style="list-style-type: none"> ■ The oven light does not come on 	<ul style="list-style-type: none"> ◆ Select a function with the oven function control knob ◆ Check the light bulb, and replace it if necessary (see "Cleaning the Oven")
<ul style="list-style-type: none"> ■ It takes too much time to finish the dishes, or they are cooked too fast. 	<ul style="list-style-type: none"> ◆ The temperature may need adjusting ◆ Refer to the contents of this booklet, especially to the chapter "Using the Oven".
<ul style="list-style-type: none"> ■ Steam and condensation settle on the food and the oven cavity. 	<ul style="list-style-type: none"> ◆ Leave dishes inside the oven no longer than 15-20 minutes after the cooking is completed.
<ul style="list-style-type: none"> ■ The programmer does not work 	<ul style="list-style-type: none"> ◆ Check the instructions for the programmer.
<ul style="list-style-type: none"> ■ The oven fan is noisy 	<ul style="list-style-type: none"> ◆ Check that shelves and bakeware are not vibrating in contact with the oven back panel.

If after all these checks, the oven still does not work, contact your local Service Force Centre quoting your model and serial number, which can be found on the rating plate.

Please note that it will be necessary to provide proof of purchase for any in-guarantee service calls.

In-guarantee customers should ensure that the above checks have been made as the engineer will make a charge if the fault is not a mechanical or electrical breakdown.

When you contact the Service Force Centre, they will need the following information:

1. Your name, address and post code.
2. Your telephone number
3. Clear and concise details of the fault
4. The model and the serial number (see rating label)
5. Date of purchase

Service and Spare Parts



If you require spare parts or an engineer contact your local Service Force Centre by telephoning:

08705-929929

Your call will be routed to the Service Centre covering your post code area. The addresses of Electrolux Service Force Centres are detailed on the following pages.

CUSTOMER CARE

For general enquiries concerning your Electrolux appliance and for further information on Electrolux products, contact our Customer Care Department by letter or telephone as follows:

Customer Care Department

ELECTROLUX

55-77 High Street

Slough

Berkshire SL1 1DZ

Tel : 08705 950950

* calls to this number may be recorded for training purposes

Guarantee Conditions

Electrolux Standard Guarantee Conditions

We, Electrolux, undertake that if, within 12 months of the date of the purchase, this Electrolux appliance or any part thereof is proved to be defective by any reason only of faulty workmanship or materials, we will, at our option, repair or replace the same **FREE OF ANY CHARGE** for labour, materials or carriage on condition that:

- * The appliance has been correctly installed and used only on the gas and electricity supply stated on the rating plate.
- * The appliance has been used for normal domestic purposes only, and in accordance with the manufacturer's instructions.
- * The appliance has not been serviced, maintained, repaired, taken apart or tampered with by any person not authorised by us.
- * All service work under this guarantee must be undertaken by a Electrolux Service Force Centre.
- * Any appliance or defective part replaced shall become the Company's property.
- * This guarantee is in addition to your statutory and other legal rights.

Home visits are made between **8.30am and 5.30pm** Monday to Friday. Visits may be available outside these hours, in which case a **premium** will be charged.

Exclusions

This guarantee does not cover:

- * Damage or calls resulting from transportation, improper use or neglect, the replacement of any light bulbs or removable parts of glass or plastic.
- * Costs incurred for calls to put right an appliance which is improperly installed or calls to appliance outside the United Kingdom.
- * Appliances found to be in use within a commercial or similar environment, plus those which are the subject to rental agreements.
- * Products of Electrolux manufacture which are not marketed by Electrolux.

European Guarantee

If you should move to another country within Europe then your guarantee moves with you to your new home subject to the following qualifications:

- * The guarantee starts from the date you first purchased your product.
- * The guarantee is for the same period and to the same extent for labour and parts as exist in the new country of use for this brand or range of products.
- * This guarantee relates to you and cannot be transferred to another user.
- * Your new home is within the European Community (EC) or European Free Trade Area.
- * The product is installed and used in accordance with our instructions and is only used domestically, i.e. a normal household
The electrical supply complies with the specification given in the rating label.
- * The product is installed taking into account regulations in your new country.

Before you move, please contact your nearest Customer Care centre, listed below, to give them details of your new home. They will then ensure that the local Service Organisation is aware of your move and able to look after you and your appliances.

France	Senlis	+33 (0)3 44 62 22 22
Germany	Nürnberg	+49 (0)911 323 2600
Italy	Pordenone	+39 (0)1678 47053
Sweden	Stockholm	+46 (0)20 78 77 50
UK	Slough	+44 (0)1753 219898

To contact your local Electrolux Service Force Centre telephone 08705 929 929

CHANNEL ISLANDS

GUERNSEY Guernsey Electricity
PO Box 4
Vale, Guernsey
Channel Islands

JERSEY Jersey Electricity
Company
PO Box 45
Queens Road
St Helier
Jersey
Channel Islands
JE4 8NY

SCOTLAND

ABERDEEN (M05) 54 Claremont Street
Aberdeen
AB10 6RA

AUCHTERMUCHY (M03) 33A Burnside
Auchtermuchy
Fife
KY14 7AJ

BLANTYRE (M07) Unit 5
Block 2
Auchenraith Industrial
Estate
Rosendale Way
Blantyre
G72 0NJ

DUMFRIES (M01) 93 Irish Street
Dumfries
Scotland
DG1 2PQ

DUNOON (M 67) Briar Hill
7 Hill Street
Dunoon
Argyll
PA23 7AL

GLASGOW (M04) 20 Cunningham Road
Clyde Estate
Rutherglen,
Glasgow,
G73 1PP

INVERNESS (M06) Unit 3B
Smithton Indust. Est.
Smithton
Inverness
IV1 2PD

ISLE OF ARRAN (OWN SALES) Arran Domestic
Unit 4 The Douglas
Centre
Brodick
Isle of Arran
KA27 8AJ

ISLE OF BARRA (OWN SALES) J Zerfah
244 Bruernish
Isle of Barra
Western Islands
HS9 5QY

ISLE OF BUTE (M66) Walker Engineering
Glenmhor
Upper Serpentine
Road
Rothesay
Isle of Bute
PA20 9EH

ISLE OF LEWIS (M69) ND Macleod
16 James Street
Stornoway
Isle of Lewis
PA872QW

KELSO (M08) 2-8 Wood Market
Kelso
Borders TD5 7AX

ORKNEY (M65) Corsie Domestic
7 King Street
Kirkwall
Orkney KW15 1RE

PERTH Hydro Electrical
Inveralmond House
Ruthervanfield Road
Perth PH1 3AQ

PERTH (OWN SALES) Graham Begg Unit 4
Airport Ind Estate
Wick KW1 4QS

SHETLAND (OWN SALES) Tait Electronic
Systems Ltd.
Holmsgarth Road
Lerwick
Shetland ZE1 0PW

SHETLAND (OWN SALES) Bolts Shetland Ltd
26 North Road
Lerwick
Shetland ZE1 0PE

WHALSAY (OWN SALES) Leask Electrical
Harisdale
Symbister, Whalsay
Shetland ZE2 9AA

NORTHERN IRELAND

BELFAST (M27) Owenmore House
Kilwee Industrial
Estate
Upper Dunmury Lane
Belfast
BT17 0HD

WALES

CARDIFF (M28) Guardian Industrial
Estate
Clydesmuir Road
Tremorfa, Cardiff
CF2 2QS

CLYWD (M14) Unit 6-7 Coed - Parc
Abergele Road
Rhuddlan
Clwyd
Wales
LL18 5UG

OSWESTRY (M17) Plas Funnon
Warehouse
Middleton Road
Oswestry
SY11 2PP

HAVERFORDWEST (M75) Cromlech Lodge
Ambleston
Haverfordwest
Pembrokeshire
SA62 5DS

DYFED (M77) Maes Y Coed
High Mead
Llanybydder
Carmarthenshire
SA40 9UL

NORTH EAST

GATESHEAD (M39) Unit 356a
Dukesway Court
Dukesway
Team Valley
Gateshead
NE11 0BH

GRIMSBY (M42) 15 Hainton Avenue
Grimsby
South Humberside
DN32 9AS

HULL (M41) Unit 1
Boulevard Industrial
Estate
Hull
HU3 4AY

LEEDS (M37) 64-66 Cross Gates
Road
Leeds
LS15 7NN

NEWTONAYCLIFFE (M45) Unit 16
Gurney Way
Aycliffe Ind Estate
Newton Aycliffe
DL5 6UJ

SHEFFIELD (M38) Pennine House
Roman Ridge Ind.

Roman Ridge Road
Sheffield
S9 1GB

NORTH WEST

BIRKENHEAD (M11) 1 Kelvin Park
Dock Road
Birkenhead
L41 1LT

CARLISLE (M10) Unit 7
James Street
Workshops
James Street
Carlisle
Cumbria CA2 5AH

ISLE OF MAN (M64) South Quay Ind.
Estate
Douglas
Isle of Man IM1 5AT

LIVERPOOL (M15) Unit 1
Honeys Green
Precinct
Honeys Green Lane
Liverpool
L12 9JH

MANCHESTER (M09) Unit B
Central Industrial
Estate
St Marks Street
Bolton
BL3 6NR

PRESTON (M13) Unit 250
Dawson Place
Walton Summit
Bamber Bridge
Preston
Lancashire
PR5 8AL

STOCKPORT (M16) Unit 20 Haigh Park
Haigh Avenue
Stockport
SK4 1QR

To contact your local Electrolux Service Force Centre telephone 08705 929 929

MIDLANDS

BIRMINGHAM (M18)	66 Birch Road East, Wyrley Road Industrial Estate Witton Birmingham B67DB
BOURNE (M44)	Manning Road Ind Estate Pinfold Road Bourne PE10 9HT
BRIDGNORTH (M72)	65 St. Mary's Street Bridgnorth Shropshire WV16 4DR
GLOUCESTER (M23)	101 Rycroft Street Gloucester GL1 4NB
HEREFORD (M31)	Unit 3 Bank Buildings Cattle Market Hereford HE4 9HX
HIGHAMFERRERS (M51)	30 High Street Higham Ferrers Northants NN10 8BB
ILKESTON (M43)	Unit 2 Furnace Road Ilkeston DE7 5EP
LEICESTER (M22)	Unit 7 Oaks Industrial Estate Coventry Road Narborough Leicestershire LE0 5GF
LINCOLN (M40)	Unit 8 Stonefield Park Clifton Street Lincoln LN5 8AA
NEWCASTLE UNDER LYME (M12)	18-21 Croft Road Brampton Industrial Estate Newcastle under Lyme Staffordshire ST5 0TW
REDDITCH (M20)	13 Thornhill Road North Moons Moat Redditch Worcestershire B98 9ND
TAMWORTH (M19)	Unit 3 Sterling Park Claymore Tamworth B77 5DO
WORCESTER (M73)	Unit 1&2 Northbrook Close Gregorys Mill Ind Estate Worcester WR3 8BP

LONDON & EAST ANGLIA

BECKENHAM (M79)	11a Gardener Ind Estate Kent House Lane Beckenham Kent BR3 1QZ
CHELMSFORD (M47)	Hanbury Road Widford Ind Estate Chelmsford Essex CM12 3AE
COLINDALE (M53)	Unit 14 Capital Park Capital Way Colindale London NW9 0EQ
ELTHAM (M78)	194 Court Road Mottingham - Eltham London SE9 4EW
ENFIELD (M49)	284 Alma Road Enfield London EN3 7BB
GRAVESEND (M57)	Unit B4, Imperial Business Estate Gravesend Kent DA11 0DL
HARPENDEN (M46)	Unit 4 Riverside Estate Coldharbour Lane Harpenden AL5 4UN
LETCHWORTH (M50)	16-17 Woodside Ind Est. Works Road Letchworth Herts SG6 1LA
LONDON (M76)	2/4 Royal Lane Yiewsley West Drayton Middlesex UB7 8DL
MAIDENHEAD (M60)	Reform Road Maidenhead - Berkshire SL6 8BY
MOLESEY (M61)	10 Island Farm Avenue West Molesey Surrey KT8 2UZ
NEWBURY (M24)	9 Pipers Court Berkshire Drive Thatcham Berkshire RG19 4ER
IPSWICH (M48)	Unit 6C Elton Park Business Centre Hadleigh Road Ipswich IP2 0DD
NORWICH (M52)	2b Trafalgar Street Norwich NR1 3HN
SUNBURY (M63)	Unit 1a The Summit Hanworth Road Hanworth Ind Estate Sunbury on Thames TW16 5D

SOUTH EAST

ASHFORD (M58)	Unit 2 Bridge Road Business Estate Bridge Road Ashford Kent TN2 1BB
FLEET (M59)	Unit 1 Redfields Industrial Estate Church Crookham Fleet Hampshire GU13 0RD
HAYWARDS HEATH (M55)	21-25 Bridge Road Haywards Heath Sussex RH16 1UA

SOUTH WEST

BARNSTAPLE (M30)	Main Road Fremington Barnstaple North Devon EX31 2NT
BOURNEMOUTH (M26)	63-65 Curzon Road Bournemouth Dorset BH1 4PW
BRIDGEWATER (M35)	6 Hamp Industrial Estate Bridgewater Somerset
BRISTOL (M25)	11 Eldon Way Eldonwall Trading Bristol Avon BS4 3QQ
EMSWORTH (M33)	266 Main Road Southboure Emsworth PO10 8JL
ISLE OF WIGHT (M34)	Unit 8 Enterprise Court Ryde Business Park Ryde Isle of Wight PO33 1DB
NEWTON ABBOT (M29)	Unit 2 Zealley Industrial Estate Kingsteignton Newton Abbot S. Devon TQ12 3TD
PLYMOUTH (M32)	16 Faraday Mill Cattledown Plymouth PL4 0ST
REDRUTH (M36)	Unit 7D Pool Industrial Estate Wilson Way, Redruth, Cornwall TR15 3QW

Technical Data

Heating elements rating

Circular heating element	2.08 kW
Inner Grill element	1.82 kW
Double Grill element	2.66 kW
Oven Light	15 W
Cooling Fan	25 W
Convection Fan	30 W
Total Rating	2.70 kW

Dimensions of recess

Height	580 mm.
Width	560-570 mm.
Depth	550 mm.

Dimensions of the oven cavity

Height	320 mm.
Width	420 mm.
Depth	390 mm.
Oven capacity	53.2 litres

Electrical Connection

The oven is designed to be connected to 230-240V (50Hz) electricity supply.

The oven has an easily accessible terminal block which is marked as follows:

Letter L	-	Live terminal
Letter N	-	Neutral terminal
 or E	-	Earth terminal



THIS OVEN MUST BE EARTHED

The cable used to connect the oven to the electrical supply must comply to the specifications given below.

For Uk use only

Connection via	Min. size Cable/flex	Cable / flex type	Fuse
<ul style="list-style-type: none"> 13 A socket outlet 13 A spur box 	2.5 mm ²	3 core butyl insulated	13 A min.
<ul style="list-style-type: none"> Cooker Control Circuit 	2.5 mm ²	PVC/PVC twin and earth	20 A

For Europe use only

Min. size Cable/flex	Cable / flex type	Fuse
1.5 mm ²	H05 RR-F	13 A

It is necessary that you install a double pole switch between the oven and the electricity supply (mains), with a minimum gap of 3mm between the switch contacts and of a type suitable for the required load in compliance with the current rules.

The switch must not break the yellow and green earth cable at any point.

Important

After installation and connecting, the cable must be placed so that it cannot at any point reach a temperature of more than 60°C above the ambient temperature.

Before the oven is connected, check that the main fuse and the domestic installation can support the load; and that the power supply is properly earthed.

The manufacturer disclaims any responsibility should these safety measures not be carried out.

Building In

Please ensure that when the oven is installed it is easily accessible for the engineer in the event of a breakdown.

BUILDING IN

The surround or cabinet into which the oven will be built must comply with these specifications:

- the dimensions must be as shown in the relevant diagrams;
- the materials must withstand a temperature increase of at least 60°C above the ambient temperature;
- proper arrangements must be made for a continuous supply of air to the oven to prevent the oven overheating.

Dimensions of the oven and recess required are given in the relevant diagrams.

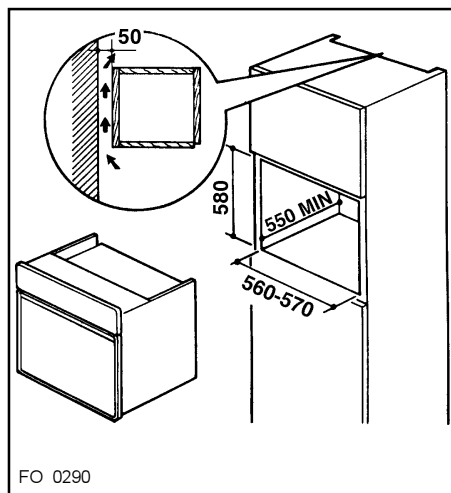
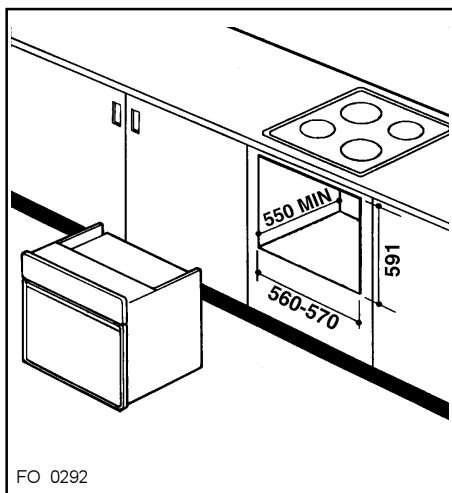
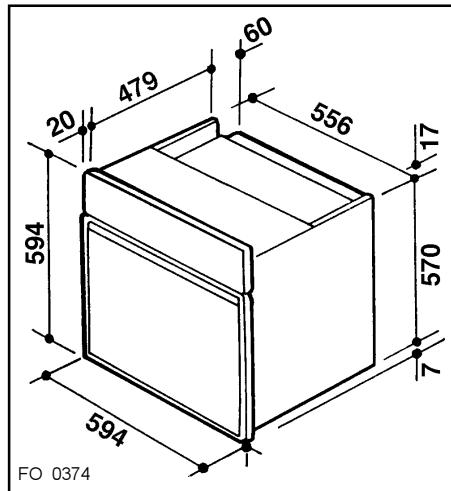

Securing The Oven To The Cabinet

1. Fit the oven into the cabinet recess,
2. Open the oven door
3. Secure the oven to the kitchen cabinet with four wood screws, which fit the holes provided in the oven frame.

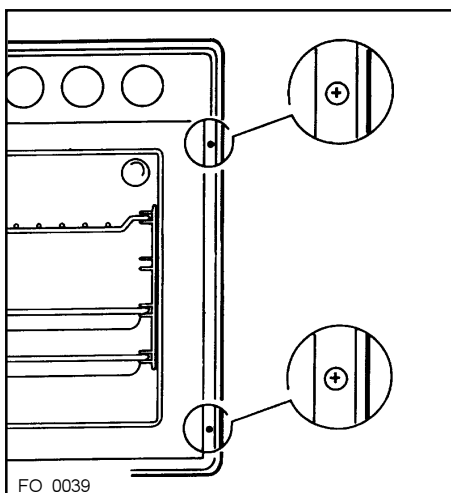

CUSTOMER CARE

55-77 High Street
Slough
Berkshire, SL1 1DZ
Tel: 08705-950950

© Electrolux Household Appliances Limited 2000